

CubePro™

Prosumer 3D Printer



Power Supply Replacement Guide

Original Instructions

COPYRIGHT

© 2014 by 3D Systems, Inc. All rights reserved. This document is subject to change without notice. This document is copyrighted and contains proprietary information that is the property of 3D Systems, Inc. Cubify, and the 3D Systems logo are registered trademarks of 3D Systems, Inc. CubePro is a trademark of 3D Systems, Inc. Use of the Cubify.com website constitutes acceptance of its Terms of Service and Privacy Policy.

FCC NOTICE

This equipment has been tested and found to comply with the limits for a Class B digital device, pursuant to part 15 of the FCC Rules. These limits are designed to provide reasonable protection against harmful interference in a residential installation. This equipment generates, uses and can radiate radio frequency energy and, if not installed and used in accordance with the instructions, may cause harmful interference to radio communications. However, there is no guarantee that interference will not occur in a particular installation. If this equipment does cause harmful interference to radio or television reception, which can be determined by turning the equipment off and on, the user is encouraged to try to correct the interference by one or more of the following measures:

- Reorient or relocate the receiving antenna.
- Increase the separation between the equipment and receiver.
- Connect the equipment into an outlet on a circuit different from that to which the receiver is connected.
- Consult the dealer or an experienced radio/TV technician for help.



NOTE: Changes or modifications to this equipment not specifically approved by 3D Systems may void the user's authority to operate this equipment.

KCC

이 기기는 가정용(B급) 전자파적합기기로서 주로 가정에서 사용하는 것을 목적으로 하며, 모든 지역에서 사용할 수 있습니다.

This equipment is home use (Class B) electromagnetic wave suitability equipment and to be used mainly at home and it can be used in all areas.

COMPLIANCE

This equipment conforms with International Electric Committee (IEC) 60950-1 and meets the requirements of the applicable EC directives.

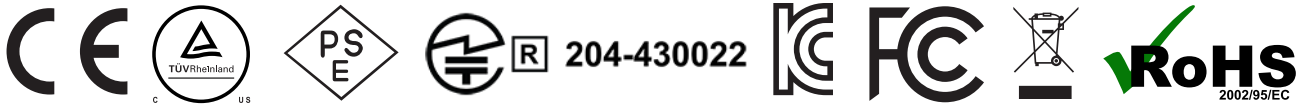

CAN ICES-3 (B)/NMB-3(B)

This device complies with Industry Canada license-exempt RSS standard(s). Operation is subject to the following two conditions: (1) this device may not cause interference, and (2) this device must accept any interference, including interference that may cause undesired operation of the device.

Le présent appareil est conforme aux CNR d'Industrie Canada applicables aux appareils radio exempts de licence. L'exploitation est autorisée aux deux conditions suivantes: (1) l'appareil ne doit pas produire de brouillage, et (2) l'utilisateur de l'appareil doit accepter tout brouillage radioélectrique subi, même si le brouillage est susceptible d'en compromettre le fonctionnement.

WARRANTY

3D Systems warrants that the CubePro 3D Printer will be free from defects in materials and workmanship, during the applicable warranty period, when used under the normal conditions described in the documentation provided to you, including this User Guide. 3D Systems will promptly repair or replace the CubePro 3D Printer, if required, to make it free of defects during the warranty period. This warranty excludes (i) normal consumable or expendable parts (such as Material Cartridges), (ii) repairs required during the warranty period because of abnormal use or conditions (such as riots, floods, misuse, neglect or improper service by anyone except 3D Systems or its authorized service provider), and (iii) repairs required during the warranty period because of the use of non-integrated, non-approved or non-licensed materials with the CubePro 3D Printer. The warranty period for the CubePro 3D printer is the shorter of (i) 90 days from the date your CubePro 3D printer is activated or (ii) 24 months after the CubePro 3D Printer is shipped from 3D Systems to the end customer or intermediary. For consumers who are covered by consumer protection laws or regulations in their country of purchase or, if different, their country of residence, the benefits conferred by our ninety (90) day warranty are in addition to, and operate concurrently with, all rights and remedies conveyed by such consumer protection laws and regulations, including but not limited to these additional rights.

THIS WARRANTY IS THE ONLY WARRANTY PROVIDED FOR THE CUBEPRO 3D PRINTER. TO THE MAXIMUM EXTENT PERMITTED BY LAW, 3D SYSTEMS EXPRESSLY DISCLAIMS ALL OTHER WARRANTIES FOR THE CUBEPRO 3D PRINTER AND EACH OF ITS COMPONENTS, WHETHER THOSE WARRANTIES ARE EXPRESS, IMPLIED OR STATUTORY, INCLUDING WARRANTIES OF MERCHANTABILITY AND FITNESS FOR INTENDED OR PARTICULAR PURPOSES.

LIMITATION OF LIABILITY

3D SYSTEMS WILL NOT BE RESPONSIBLE FOR INDIRECT, SPECIAL, CONSEQUENTIAL, EXEMPLARY OR INCIDENTAL DAMAGES (SUCH AS LOSS OF PROFIT OR EMPLOYEE'S TIME) REGARDLESS OF THE REASON. IN NO EVENT SHALL THE LIABILITY AND/OR OBLIGATIONS OF 3D SYSTEMS ARISING OUT OF THE PURCHASE, LEASE, LICENSE AND/OR USE OF THE EQUIPMENT BY YOU OR OTHERS EXCEED THE PURCHASE PRICE OF THE CUBEPRO 3D PRINTER.

Warranty Hotline from the Americas

888-598-1440 inside the US and
+1 678-338-3480 outside the US
weekdays during normal business hours
or by email at cubifysupport@cubify.com.

Warranty Hotline from Europe

+44 1442 279 839 (UK) or
+49 6151 357 499 (DE) weekdays during
normal business hours or by email at
cubifysupport@cubify.com.

Warranty Hotline from Europe

+44 1442 279 839 (UK) or
+49 6151 357 499 (DE) weekdays
during normal business hours or by
email at cubifysupport@cubify.com.

2 IMPORTANT SAFETY INFORMATION

SAFETY SYMBOLS AND DEFINITIONS



HOT SURFACE HAZARD: A HOT SURFACE IS ACCESSIBLE IN THE VICINITY OF THIS SIGN OR AT THE PRINT JET. AVOID CONTACT WITH THESE AREAS. HOT SURFACES CAN CAUSE SEVERE BURNS.



Caution: Indicates something may happen that could cause loss of data, damage to equipment, or could cause personal injury.



Caution: Indicates a pinch point hazard that could cause personal injury.



SHOCK WARNING: INDICATES A POTENTIAL SHOCK HAZARD.

SAFETY GUIDELINES

- Follow all safety rules in this section and observe all cautions and warnings in this guide.
- Do not modify any safety features or make modifications to the CubePro. Doing so is prohibited and voids the warranty.
- Use of print materials other than genuine 3D Systems components may void the warranty.



WARNING: HAZARDOUS MOVING PARTS. KEEP FINGERS AND OTHER BODY PARTS AWAY.



HOT SURFACE HAZARD: DO NOT TOUCH THE PRINT JETS DURING SETUP AND OPERATION. THE PRINT JETS BECOME VERY HOT.



Caution: Read and follow all instruction prior to setting up the printer.



SHOCK WARNING: DUE TO RISK OF SHOCK, AVOID CONTACT WITH ALL INTERNAL ELECTRONIC COMPONENTS.



WARNING: THE CUBEPRO SHOULD ONLY BE SERVICED BY AUTHORIZED SERVICE TECHNICIANS. PRIOR TO ANY PART REPLACEMENT PROCEDURE, THE PRINTER MUST BE POWERED OFF AND DISCONNECTED FROM UTILITY POWER.



HOT SURFACE HAZARD: WHEN PRINTING WITH ABS MATERIAL, THE INTERIOR (PRINT CHAMBER) OF THE PRINTER WILL HEAT TO A PREDETERMINED TEMPERATURE. THE SURFACE OF THE PRINT CHAMBER HEATER WILL BE HOT. AVOID CONTACT WITH THE PRINT CHAMBER HEATER AND NOTE THAT OTHER COMPONENTS INSIDE THE PRINT CHAMBER MAY BE HOT.

To ensure safety, please exercise caution when operating your CubePro. Read and follow all safety precautions as outlined in this user guide. Be careful when operating your CubePro to ensure proper printing and be mindful of and avoid hot surfaces.

3 AT A GLANCE

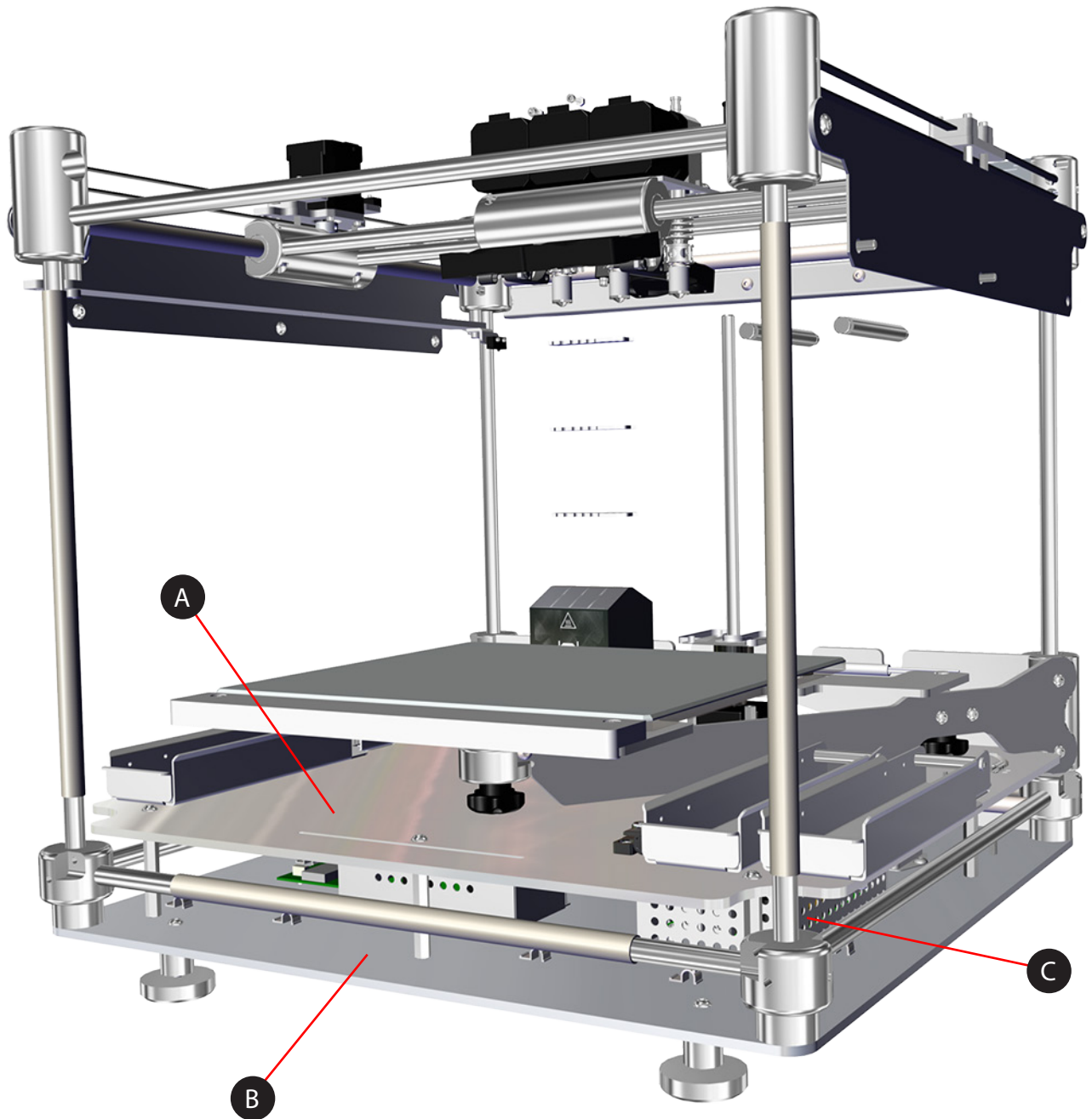

- A Inner Floor
- B Outer Floor
- C Power Supply

CONNECTIONS

Front

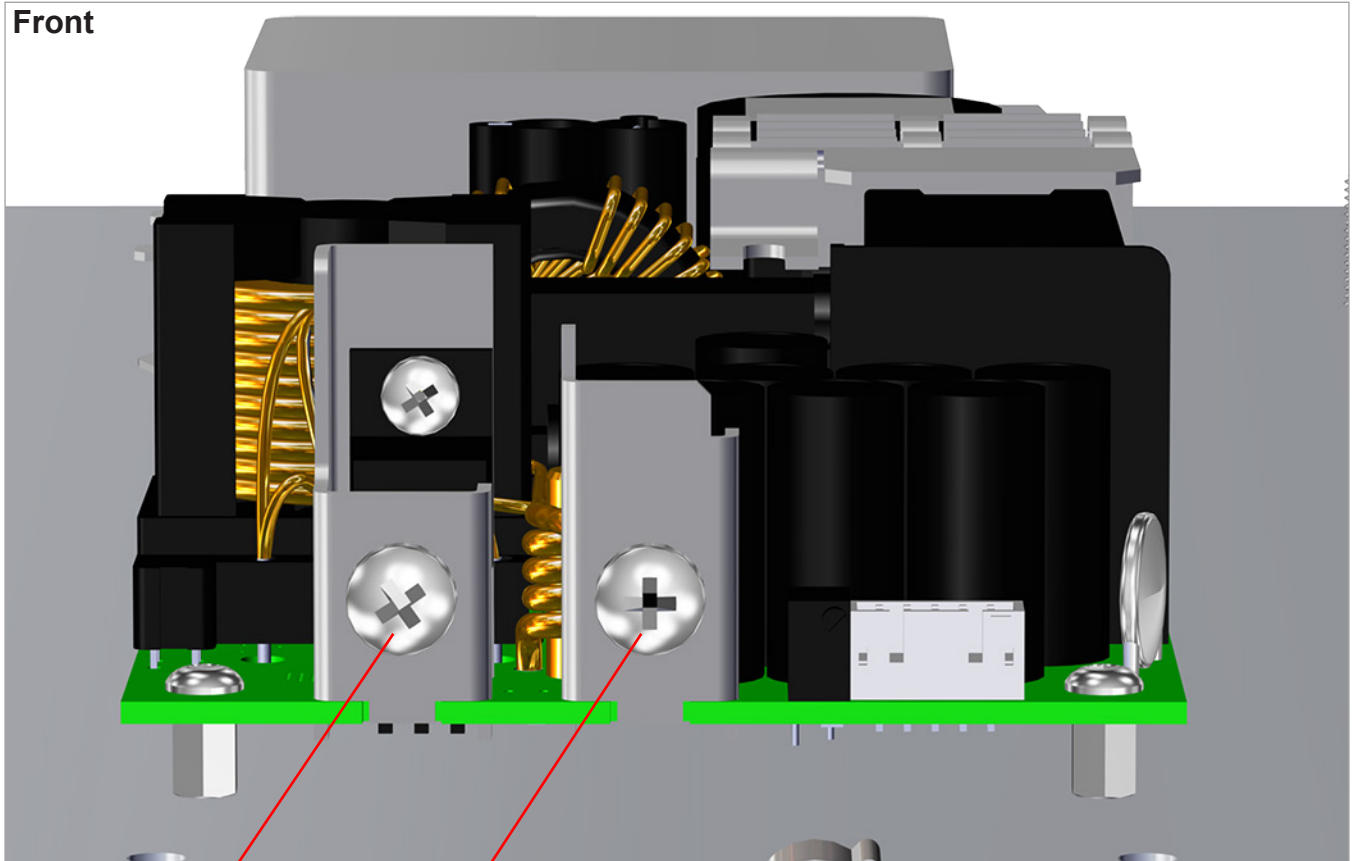

Direct Current Side

A

B

A Positive Connection

B Negative Connection

Positive Connection	Negative Connection
401894 - Gray Wire	401884 - Green Wire and Yellow Wire
Main PCB Fan - Red Wire	Main PCB Fan - Black Wire
	401889-00 - Green Wire

Rear

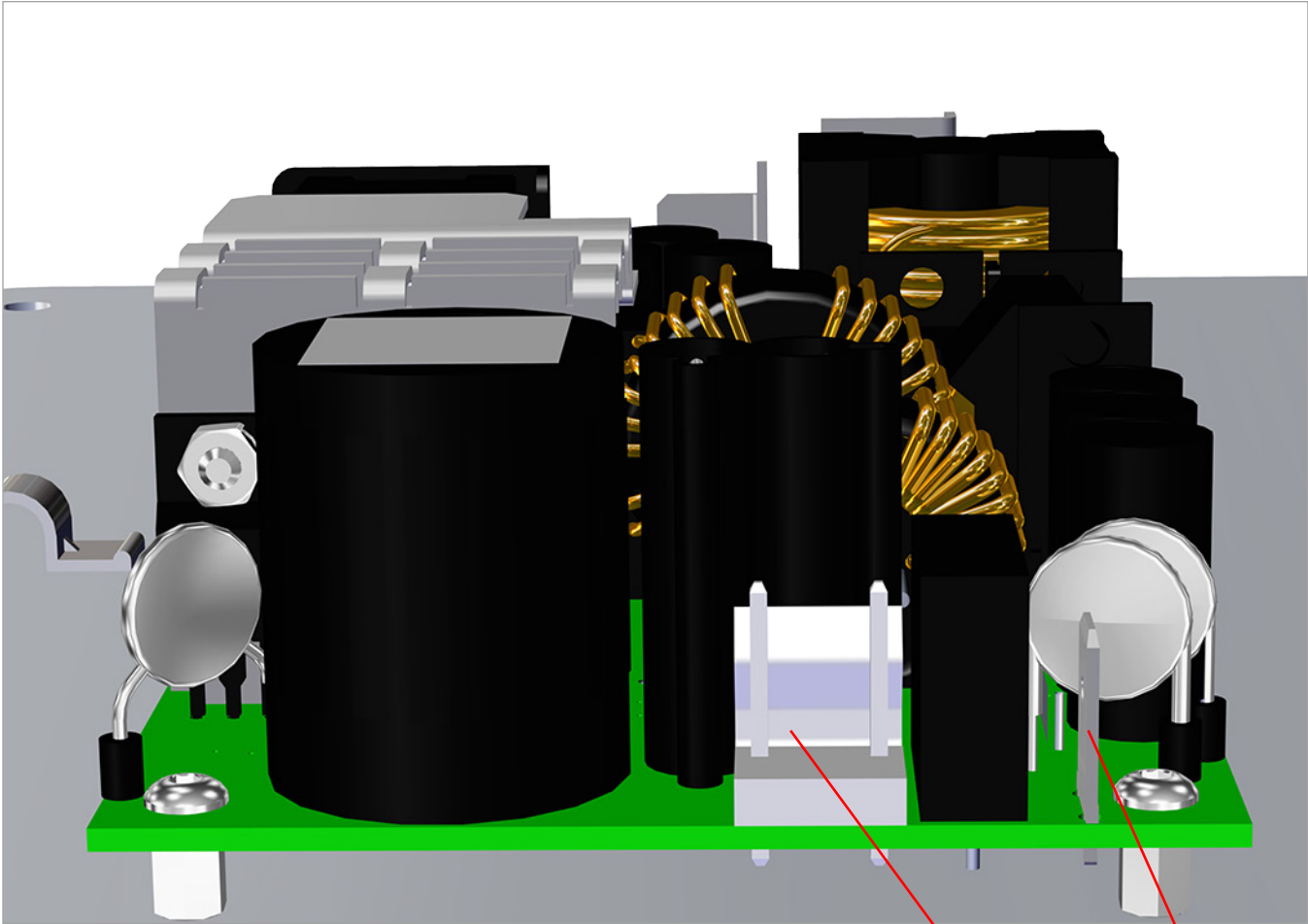

Alternating Current Side

A

B

A 401882 - Blue Wire and Brown Wire

B 401883 - Green/Yellow Wire

4 REPLACING THE POWER SUPPLY

TOOLS NEEDED

- 2 mm Hex Driver
- 3 mm Hex Driver
- #2 Phillips Screwdriver

REPLACING THE POWER SUPPLY



WARNING: BEFORE SERVICING THESE COMPONENTS, ENSURE YOU ARE WEARING A WELL-GROUNDED ELECTRO-STATIC DISCHARGE (ESD) STRAP. ESD PROTECTION IS REQUIRED.



WARNING: NEVER PULL ON WIRES TO DISCONNECT THE CONNECTORS. THIS COULD DAMAGE THE WIRES AND THE CONNECTORS AND VOID THE MANUFACTURER'S WARRANTY.



WARNING: EVEN AFTER THE PRINTER HAS BEEN TURNED OFF AND DISCONNECTED FROM UTILITY POWER, IT IS POSSIBLE TO STILL CONTAIN RESIDUAL VOLTAGE. EXTREME CAUTION IS REQUIRED.

1. Remove all print cartridges and the jet wiper assembly.



NOTE: Refer to the section titled Replacing A Material Cartridge in chapter 6 of the User Guide.

2. Navigate to the **Print Pad Calibration** screen and select **LEVEL PLATE**.

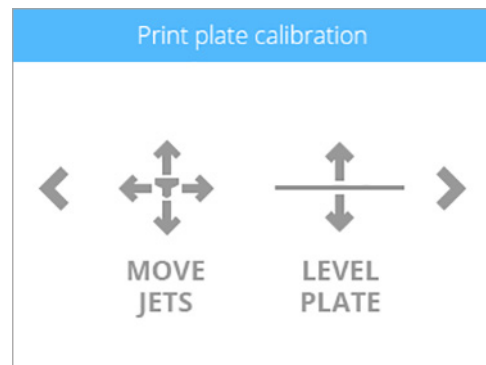

3. Once the print pad has raised, turn off the main power switch on the right side of the printer.
4. Disconnect the power cord from the printer.



WARNING: THE PRINTER MUST BE DISCONNECTED FROM UTILITY POWER BEFORE PROCEEDING.

5. Using a 3 mm hex head driver, loosen and remove all nine (9) 3mm hex head bolts securing the inner floor. Retain the screws for reassembly.

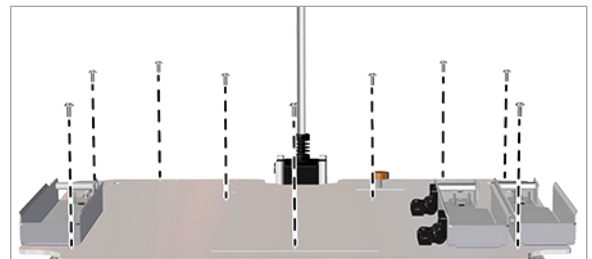

- Lift the front edge of the floor and secure it through the slot to the front chassis crossbar with a zip tie.

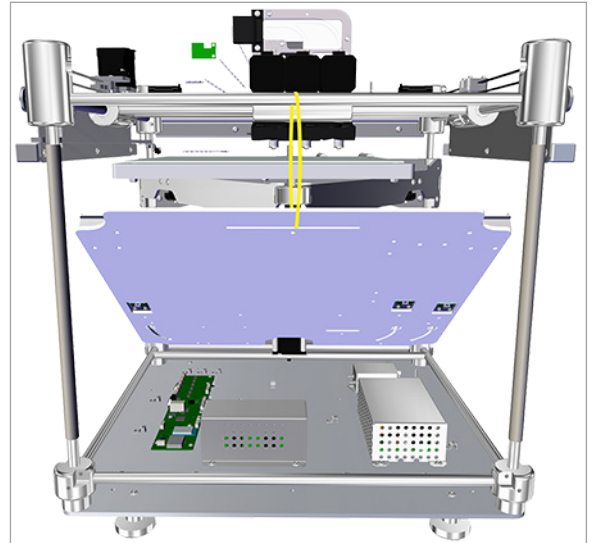

- Using a 3 mm hex driver, loosen and remove all four (4) screws securing the power supply cover to the inner floor and remove the cover.

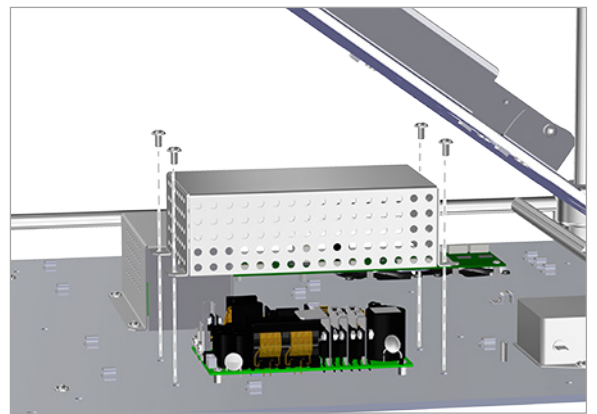

- Using a Phillips screwdriver, loosen and remove both (2) Phillips screws securing the wire connectors to the positive and negative terminals. Retain the screws for reinstallation.



NOTE: Make note of each connection so they will be reconnected properly during reassembly.

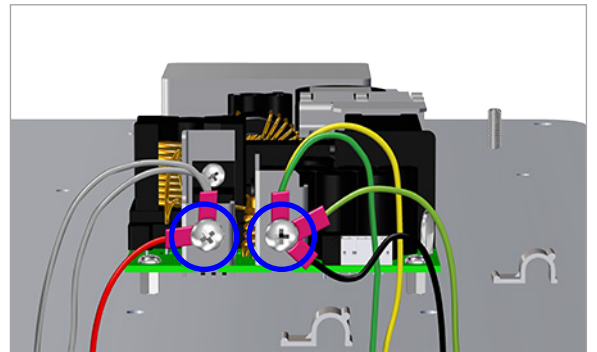

- Remove the 401883 blade connector (A) from the blade terminal. Carefully disconnect 401882 (B), the two (2) pin connector, from the power supply.

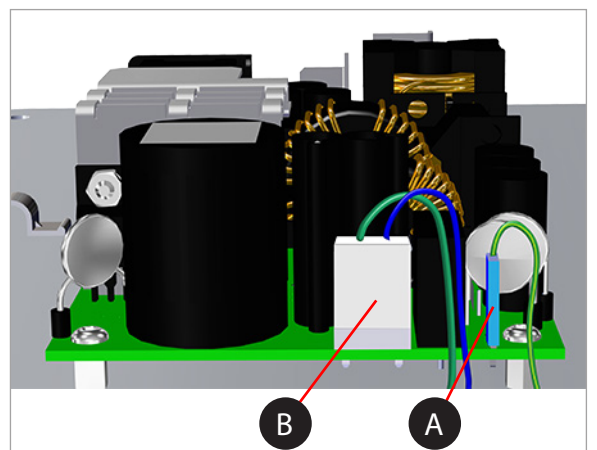

10. Using a 2 mm hex driver, loosen and remove the four (4) screws securing the power supply to the standoff pins and remove the power supply.



NOTE: The screws will be reused for reassembly.

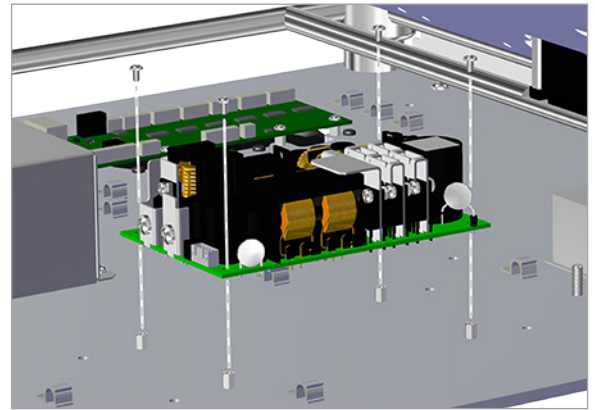

11. Place the new power supply over the standoffs and insert the original screws.



CAUTION: EXERCISE CAUTION WHEN WORKING AROUND CIRCUIT BOARDS. COMPONENTS ARE EASILY DAMAGED AND ANY DAMAGE MAY VOID YOUR MANUFACTURER'S WARRANTY.

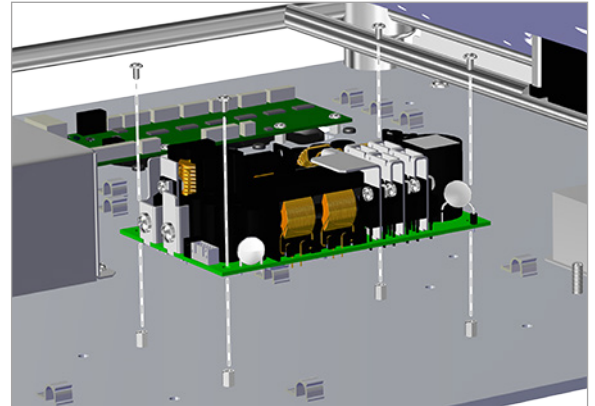

12. Using the 2 mm hex driver, carefully tighten the screws to secure the power supply.



CAUTION: DAMAGE TO THE POWER SUPPLY CAN OCCUR IF THE SCREWS ARE OVER-TIGHTENED. EXERCISE CAUTION WHEN TIGHTENING THE SCREWS.

13. Carefully connect the blade connector (A) and the two (2) wire connector to the back of the power supply.



NOTE: Depending on your printer model, some junctions may not be used. Refer to your notes and the connections diagram on page 4. If you need further assistance, contact support.

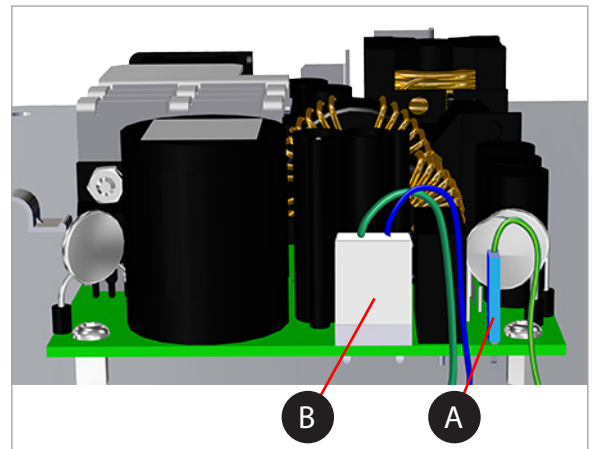

- Using a Phillips screwdriver, reconnect the wire connectors to both the positive terminal and negative terminal using the original two (2) screws.

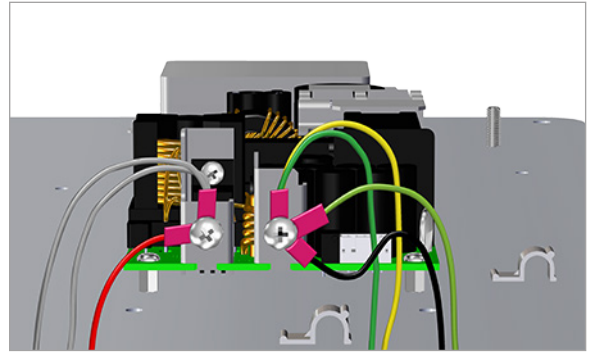

- Reinstall the power supply cover. Insert the original four (4) 3 mm hex head screws through the cover and into the inner floor and secure them.



NOTE: To prevent damaging the wires, ensure the wires are routed under the wire openings on the front and back of the cover.

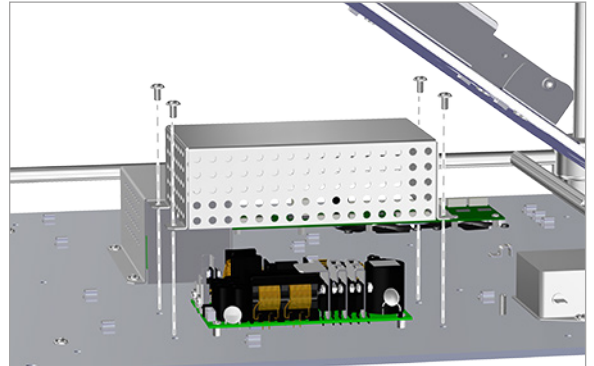

- While supporting the floor, carefully remove the wire tie.

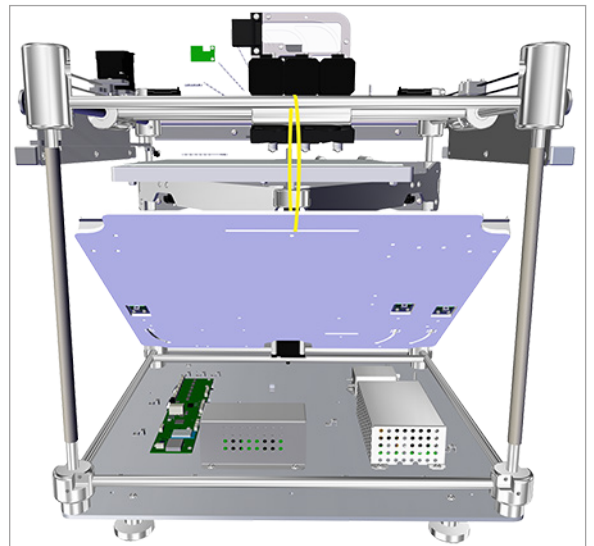

- Lower the inner floor and align the screw holes with the standoffs underneath.
- Insert the original nine (9) screws that were removed in step 5 and secure them using a 3 mm hex driver.

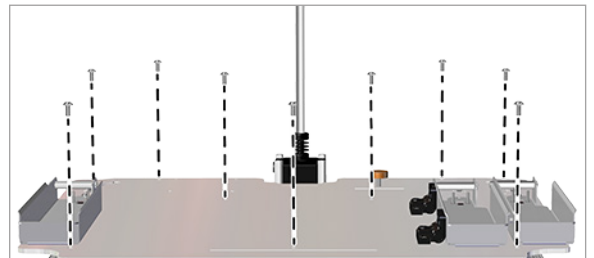

- Connect the power cord to the printer and turn on the main power switch. Press the on/off button to turn on the display.



3D Systems, Inc.

333 Three D Systems Circle | Rock Hill, SC | 29730

www.3dsystems.com

©2014 3D Systems, Inc. All rights reserved.

PN: 403169-00 Rev. A